

## FAST Series - Field Installable Pre-Polish Connectors

FAST – Field Assembly with Simple Technique

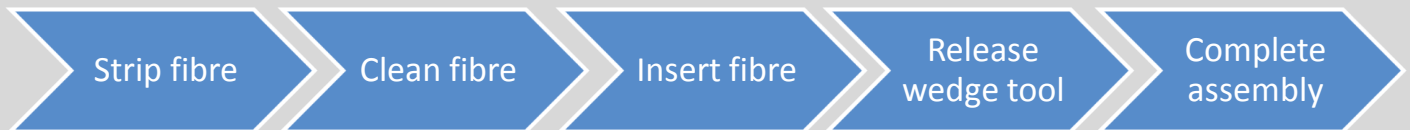

### Assembly in 5 easy steps



#### Clamping mechanism:

##### 900µm Fibre Clamping

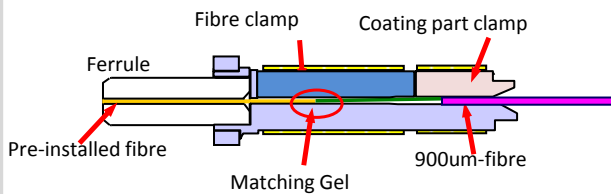

##### 250µm Fibre Clamping

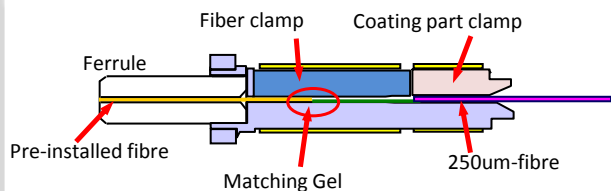

#### Key Features & Benefits:

- Connector termination in less than a minute
- No messy epoxy
- Termination to both 0.25mm & 0.9mm Ø fibre
- Variants available for >2.0mm & >3.0mm Ø fibre
- No specialised tooling required
- No specialised training required
- Low Insertion Loss & Back Reflection

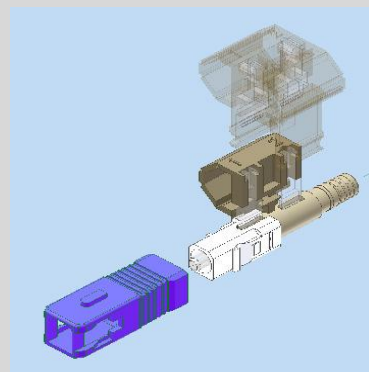

## Connector dimensions:

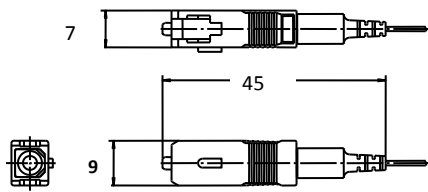

FAST-SC: L 45 \* W7.4 \* H 9 (mm)

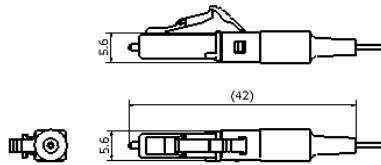

FAST-LC: L42 \* W5.6 \* H5.6 mm

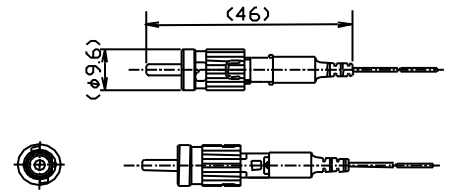

FAST-ST ; L 46 \* Dia. 9.6 (mm)

## Connector variants:

Connector \ Fibre	Fibre			
	Single-mode	Graded Index 50/125µm	Graded Index 62.5/125µm	OM3 Compliant
SC/PC (0.25/0.9mm)	○	○	○	○
SC/PC (2.0/3.0mm)	○	○	○	○
SC/APC (0.25/0.9mm)	○	-	-	-
SC/APC (2.0/3.0mm)	○	-	-	-
ST/PC (0.25/0.9mm)	○	○	○	○
ST/PC (2.0/3.0mm)	○	○	○	○
LC/PC (0.25/0.9mm)	○	○	○	○
LC/PC (2.0/3.0mm)	○	○	○	○
LC/APC (0.25/0.9mm)	○	-	-	-
LC/APC (2.0/3.0mm)	○	-	-	-

## Optical performance:

No.	Test	Fibre Type	Wavelength	Mean Loss (dB)	Max. Loss (dB)
1	Insertion Loss	SM	1310nm	0.16	0.37
			1550nm	0.14	0.36
		GI 50/125	1310nm	0.06	0.09
		GI 62.5/125	1310nm	0.04	0.07
		OM3	1310nm	0.07	0.015
		SM (APC)	1310nm	0.18	0.39
			1550nm	0.18	0.39
No.	Test	Fibre Type	Wavelength	Mean Loss (dB)	Min. Loss (dB)
1	Return Loss	SM	1310nm	56.1	43.9
			1550nm	56.4	44.5
		SM (APC)	1310nm	69.2	65
			1550nm	70.5	65.1